



# METROLOGY LAB PRECISION ON THE PRODUCTION LINE

ISO 17025 accredited



25+ YEARS OF METROLOGY EXPERIENCE



## THE INLINE SOLUTION

---

### **Rely on a robust tool**

Proven to take 1 million measurements in one year.

### **Take ultra-fast measurements**

The GapGun PRO2 has a measurement cycle of just 1 second.

### **Enjoy a portable and ergonomic tool**

The GapGun PRO2 can be taken to the part and can run for up to 8 hours.  
100% operator approved.

## THE TOOL FOR OFFLINE QUALITY CONTROL INSPECTION

---

### **Measure 100s of points of the car easily**

The full colour graphic check plans can be tailored to your application and show operators exactly where to measure.

### **Ensure an audit trail for all measurements**

GapGun PRO2 captures measurement digitally. Sensors are calibrated in an ISO17025 certified laboratory.

### **Get repeatable results**

For the sharpest business intelligence.



“Our new handheld laser scanners from Third Dimension ensure perfect consistency in all body surfaces to a tolerance of just 0.025 mm for panel gaps, and 0.01 mm for flush measurements – imperceptible to the human eye. One colleague can do 140 checks in 6 minutes! Due to global demand for our products we must also ensure efficiency, so our colleagues’ skills are increasingly augmented by innovation and cutting edge technology.”

**Automotive OEM UK**



Fast



Accurate

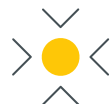

Repeatable



Non-contact



Tracable

# THE GAPGUN PRO2 COMES EQUIPPED WITH A MARKET LEADING RANGE OF FEATURES

---





## **CREATE BESPOKE CHECKPLANS**

SPC3d Software lets you define sequences of measurements including photos that users can follow with minimal training.



## **SHARE MEASUREMENT PLANNING**

Manage multiple GapGun PRO2s using one software, SPC3d, and have multiple operators working at once from one plan.



## **TOUCH SCREEN INTERFACE**

Navigate through checkplans easily with GapGun PRO2's touch screen.



## **EXPORT MEASUREMENT RESULTS EASILY**

Export measurement results easily to CSV, SQL, XML, Excel, PDF and other file formats. Interface with most leading SPC packages such as QDAS.



## **ON SCREEN RESULTS ANALYSIS**

View cross sections of the measurement area and results analysis on-screen using standard red/green colouring conventions and warning sounds to indicate go/no go conditions.



## **CHANGEABLE SENSOR HEADS**

Our trademarked "VChange" mechanism mean you can switch between sensor heads easily and quickly.



## **ACCESS HARD-TO-REACH PLACES WITH EXTENSION CABLE**

Take measurements in awkward and small places, when you use the sensor head extension cable.



## **FULLY INTEGRATED WI-FI CAPABILITY**

Feed measurement back to your production systems in real-time.



## **MULTIPURPOSE DESK DOCK CABLE**

Download data straight to the PC and charge simultaneously.



## **HI-RANGE SENSOR HEAD CAPABILITY**

Measure a range of surfaces including head lights, chrome, high gloss black paint and carbon fibre.

# ONE TOOL

# INFINITE APPLICATIONS



**GAP AND FLUSH INTERIORS**

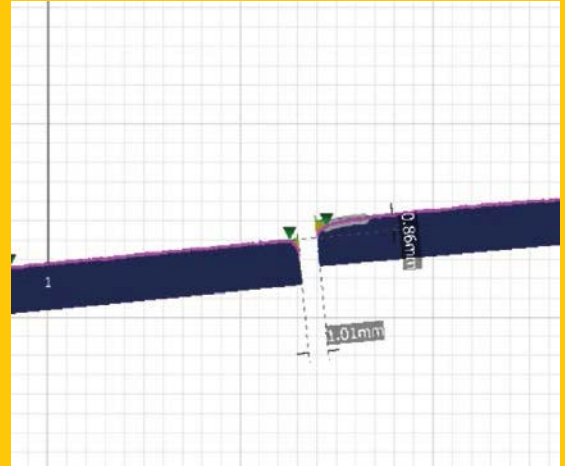

**GAP AND FLUSH EXTERIORS**

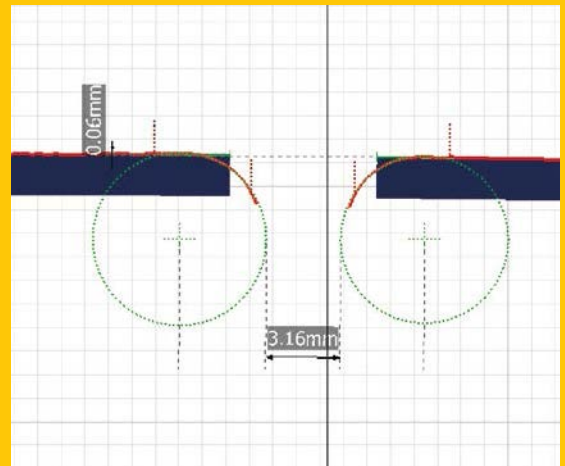

**GAP AND FLUSH LIGHTS**

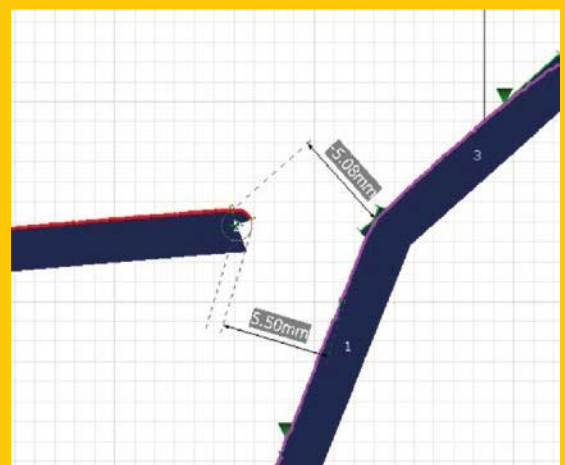



**RADII**

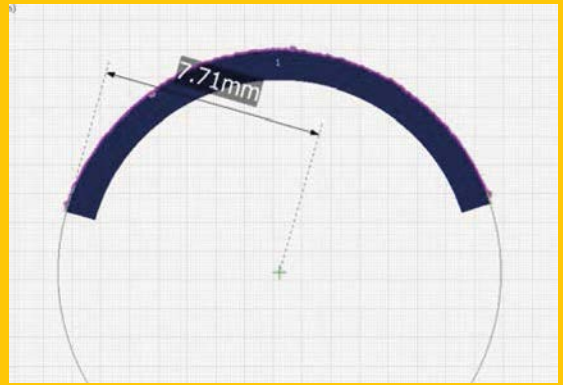

**CHAMFERS**

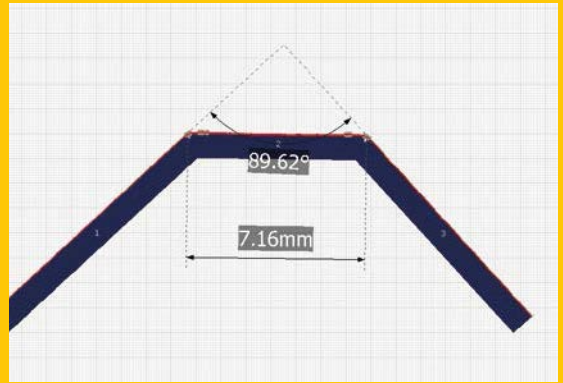

**WELD AND SEALS**

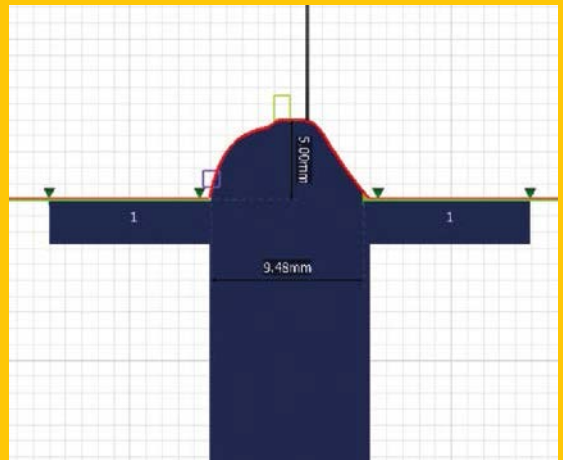

**ANGLES**

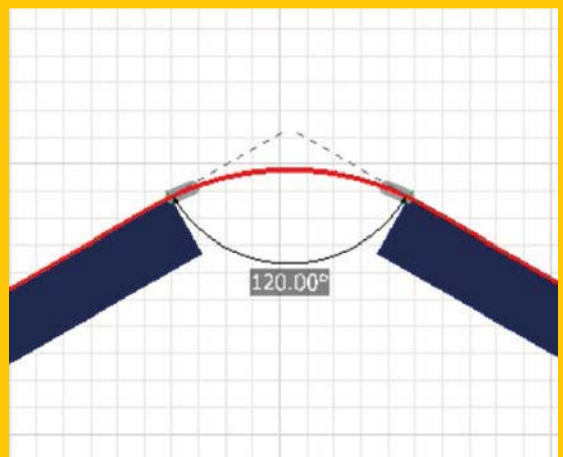

# T-SERIES SENSOR HEAD SPECIFICATION



Sensor head T60-V



Sensor head T15-M

Laser	Laser Class 2M with automatic laser intensity adjustment
Operating temperature	0 to 40°C (32 to 104°F)
Shock protection	Shock protection jacket on sensor, and high impact plastic housing
Software	GapGun version 8.1 software
Operating temperature	0 to 40°C (32 to 104°F)
Storage temperature	-20°C to 60°C (-4 to 140°F)
Traceability and calibration	Calibrated under ISO 17025***

	T60		T15	
Example Measurement capability*				
Gap = 0.3 mm	Max bias 0.06	Max SD**0.025	Max bias 0.03	Max SD**0.015
Flush = 1 mm	Max bias 0.04	Max SD**0.01	Max bias 0.03	Max SD**0.01
Radius 0.25 to 1.0mm			Max bias 0.013	Max SD**0.005
Edge radius 0.25 to 1.9mm			Max bias 0.015	Max SD**0.02
Chamfer 0.25 to 1.9mm			Max bias 0.015	Max SD**0.012
Field of view	60 mm		15 mm	
Size	41 x 56 x 99 (1.6x2.2x3.9") WxDxH, Inc jacket		36x60x83mm (1.2x1.9x2.7") WxDxH, Inc jacket	
Weight	170g (5.9 oz)		175g (6.1 oz)	

\*according to D19-034 Third Dimension specification under request

\*\*Standard deviation

\*\*\*Gap and Flush

## ACCESSORIES AND OPTIONS

### Included

Docking Station	Charge the GapGun PRO2 and upload data directly to a PC.
Battery Pack	Use for longer with the light-weight battery pack.
Belt Clip	Carry the GapGun PRO2 with ease.
Calibration Block	Calibrate with ease.
Standard Stand-off set	Enables fast and reproducible measurements.

### Optional

Head Extension Cable	Take measurements in tight and hard to access locations.
Customised Stand-off set	Custom standoffs available on request.
Specific Calibration	We offer specific calibration services under request.

**YOUR LOCAL DISTRIBUTOR WILL BE HAPPY TO HELP ADVISE YOU ON THE BEST SENSOR HEAD AND ACCESSORIES FOR YOUR APPLICATION. TO FIND A DISTRIBUTOR NEAR YOU SIMPLY EMAIL [SALES@THIRD.COM](mailto:SALES@THIRD.COM)**



# GAPGUN PRO2 DATA COLLECTOR



Display	Full colour, daylight readable LCD touchscreen
Size	97mm (3.8")
Resolution	640 x 480 pixel
Ethernet	100MBPS fast ethernet
Feedback	Audio output and haptic feedback
Operating temperature	0 to 40C (32 to 104F). Internal battery charging limited at higher temperatures
Peripheral devices	USB 2.0 port
Power rating (battery)	4W (4.2v @ 0.95A)
Power rating (charging)	6W (12v @ 0.5A)
Shock protection	Shock protecting cover on sensor and handle, and high impact plastic housing
Size	90 x 135 x 190mm (3.5 x 5.3 x 7.5") W x D x H)
Software	GapGun version 8 software
Storage temperature	-20°C to 60°C (-4 to 140°F)
User interface	Click and drag touchscreen, trigger and power/reset button
Weight	460g (16oz)
Wireless	IEEE 802.11 b,g,n

## COMPATIBLE PC SOFTWARE



### SPC3d software pack

For checkplan configuring virtual measurement tools, data logging, reviewing measurements.



### Link software pack

Allows custom .NET programs to be written controlling the GapGun PRO2 or Vectro devices.



### Inspect software pack

For manual and interactive analysis of measurement data.



### Inline software pack

Allows a large overhead display of measured results.

## WARRANTY AND SERVICE

1-Year warranty as standard on GapGun PRO2 and all sensor heads.

Maintenance contracts available for hardware and software, bespoke software and hardware development.

Please contact your local Distributor or [sales@third.com](mailto:sales@third.com) for more information.



# ABOUT

---

UK based company, Third Dimension design and manufacture the non-contact precision measurement systems, GapGun® (hand-held) and Vectro® (robotic). Established in 1995, Third Dimension has a long track record of supplying non-contact optical measurement equipment and services to the largest names in aerospace, automotive and energy sectors worldwide.

Holder of two Queen's Awards for Enterprise, our systems have been fully integrated into quality control processes by leading OEMs, Tier 1s and 2s in the automotive, aerospace and energy sectors, worldwide.

Achieving ISO 17025 status in 2019, Third Dimension continue to lead the way in non-contact precision measurement tooling.



**"GapGun is the ideal tool for quickly and accurately measuring small gaps and profiles throughout the plane panels... it has saved time and money throughout the production process."**

**Aerospace OEM** Germany

## ARRANGE A DEMONSTRATION TODAY

---

Contact one of our expert Distributors in your area to arrange a free demonstration in your factory.

### **Unsure of who your local Distributor is?**

Simply call +44(0)3333 44 3000 or email [sales@third.com](mailto:sales@third.com) and we will talk through your requirements and put you in contact with the nearest Distributor to you.

# GET IN CONTACT

 +44(0)3333 443 000

 [sales@third.com](mailto:sales@third.com)

 [www.third.com](http://www.third.com)

## FOLLOW US

 [@thegapgun](https://twitter.com/thegapgun)

 [ThirdDim](https://www.facebook.com/ThirdDim)

 [Third-dimension](https://www.linkedin.com/company/third-dimension)

Authorised Distributor

# CUSTOMERS

Third Dimension's distribution network serves customers in 30+ countries worldwide. These include:



GapGun and Vectro systems are designed, developed and manufactured by:

**THIRD DIMENSION**  
ADVANCING MANUFACTURING

Third Dimension, 2 Brabazon Office Park, Golf Course Lane, Filton, Bristol, BS34 7PZ, United Kingdom.

Tel: +44(0)3333 44 3000 Email: [info@third.com](mailto:info@third.com) ©2022 Third Dimension Software Ltd.

All Rights Reserved.